

HAWA POCKET SHELL FOLDING DOOR CABINET

ZONAVITA

FOR MODERN LIFE

PACKAGED PARTS

Inner Panel
with Hardware

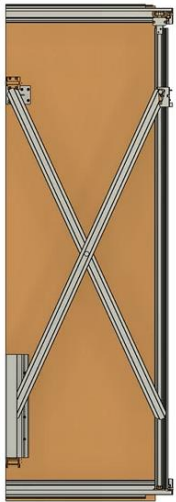

Top Floor Inner



Inner Panel
without Hardware



End Panel



Running Track



Hinge Door



Bifold Door



Running Gear



HAWA POCKET SHELL FOLDING DOOR CABINET

ZONAVITA

FOR MODERN LIFE

INSTALL INSTRUCTIONS

1. Unpackage the Inner Panel with Hardware, Top Floor, and Inner Panel without Hardware.
 - Note the space behind the hardware which can be used for L-brackets or wood blocking to attach pocket shell to the wall. See blue line.
 - If scribing, then it is recommended to scribe these pieces now before they are assembled to create the pocket shell.

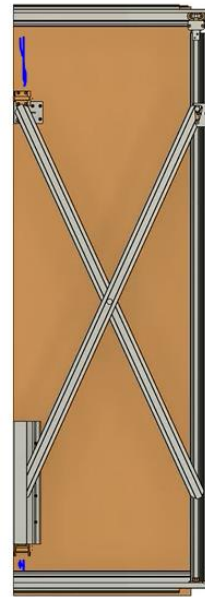

2. Install the Top Floor to the Inner Panel with Hardware using the supplied Minifix hardware.



3. Install the Top Floor to the Inner Panel without Hardware using the supplied Minifix hardware.

HAWA POCKET SHELL FOLDING DOOR CABINET

ZONAVITA

FOR MODERN LIFE

4. Install the Pocket Shell to the wall.

- Use installer supplied L-brackets or wood blocking to attached pocket shell to the wall.
- It is important to adjust and level the sides and front of the pocket shell at this stage as there is not a lot of adjustment in the doors.



- ## 5. Install the End Panel to the pocket shell. It slides in from the front. Once in place, then tighten the bolt on top and bottom of the hardware. See blue circle.



HAWA POCKET SHELL FOLDING DOOR CABINET

ZONAVITA

FOR MODERN LIFE

5. Attach the Running Track.

- Slide it into place and use the Allen wrench to tighten screws.

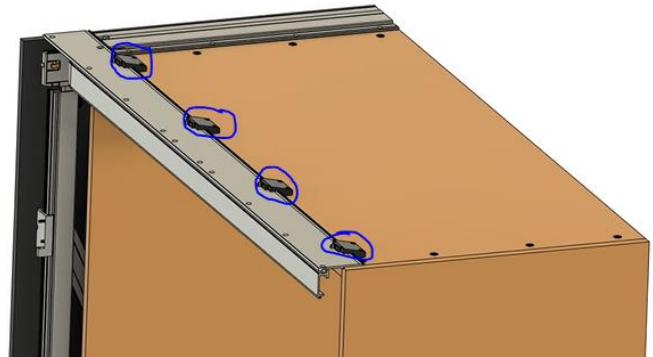

6. Attach the Hinge Door.

- Once the door is attached, then tighten each hinge using the supplied Allen wrench. Note that there are 2 screws per hinge to tighten.

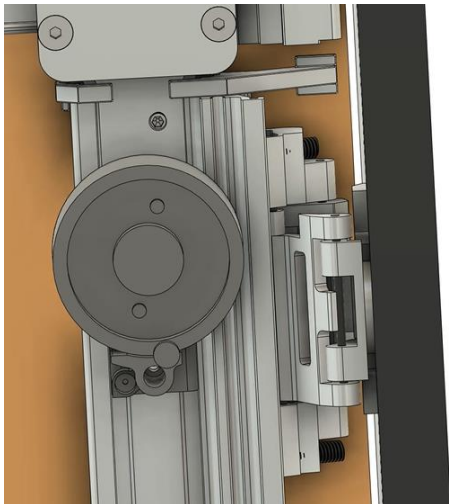

HAWA POCKET SHELL FOLDING DOOR CABINET

ZONAVITA

FOR MODERN LIFE

7. Attach the Bifold Door.

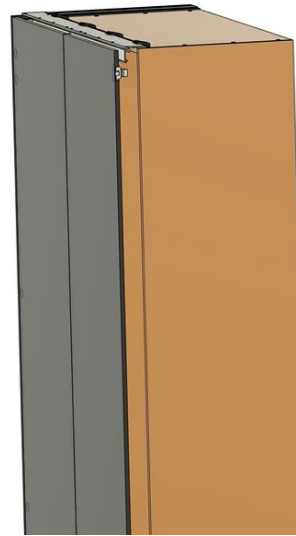
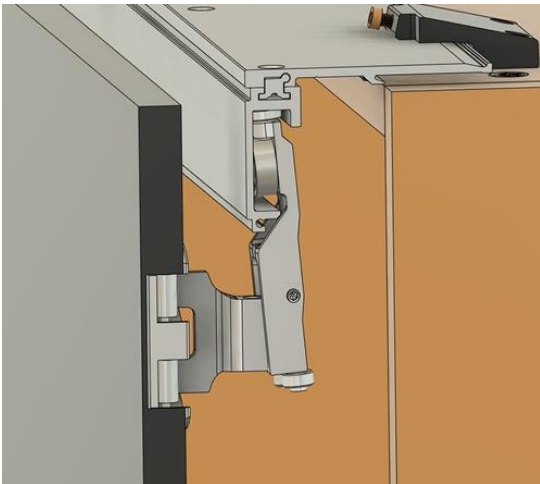

8. Install the Running Gear and tighten with Allen wrench at the bottom.

8. Once everything is in place, then make any appropriate adjustments and level the door before continuing to install any inner cabinets or products if they are part of the design.

